



# JT050N120GPEd

## 主要参数 MAIN CHARACTERISTICS

|                        |       |
|------------------------|-------|
| I <sub>c</sub>         | 50A   |
| V <sub>CE</sub>        | 1200V |
| V <sub>cesat-typ</sub> | 2.0V  |

### 用途

- 逆变器
- UPS 电源

### APPLICATIONS

- General purpose Inverters
- UPS

### 产品特性

- 低栅极电荷
- Trench FS 技术
- RoHS 产品

### FEATURES

- Low gate charge
- Trench FS Technology
- RoHS product

## 封装 Package

TO-247plus

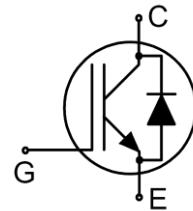

TO-247plus

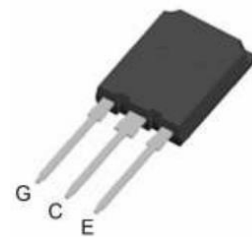

## 印记定义

## Mark definition

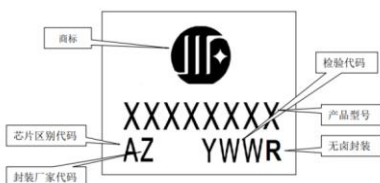

印章定义:

产品型号说明: 产品类型+工艺平台+电流+频率+电压+工艺版本+特殊特性。

检验代码说明: Y(年代码, 执行内部定义)+WW (周代码)

## 订货信息 ORDER MESSAGE

| 订货型号 Order codes           | 印记 Marking    | 封装 Package |
|----------------------------|---------------|------------|
| 无卤-条管<br>Halogen-Free-Tube |               |            |
| JT050N120GPEd-GE-BR        | JT050N120GPEd | TO-247plus |

绝对最大额定值 ABSOLUTE RATINGS ( $T_C=25^{\circ}\text{C}$ )

| 项 目<br>Parameter   | 符 号<br>Symbol                  | 数 值 Value                       | 单 位<br>Unit        |
|--|--------------------------------|---------------------------------|--------------------|
| 最高集电极-发射极直流电压<br>Collector-Emitter Voltage   | $V_{CE}$                       | 1200                            | V                  |
| *连续集电极电流<br>Collector Current-continuous   | $I_C$                          | 100( $T_C=25^{\circ}\text{C}$ ) | A                  |
|  |                                | 50( $T_C=100^{\circ}\text{C}$ ) | A                  |
| 最大脉冲集电极极电流 (注 1)<br>Collector Current – pulse<br>(note 1)                                    | $I_{CM}$                       | 200                             | A                  |
| 二极管正向电流<br>Diode RMS forward current   | $I_F$                          | 100( $T_C=25^{\circ}\text{C}$ ) | A                  |
|  |                                | 50( $T_C=100^{\circ}\text{C}$ ) | A                  |
| 二极管正向不重复峰值电流 (浪涌电流)<br>Surge non repetitive forward current $t_p=10\text{ ms}$<br>sinusoidal | $I_{FSM}$                      | 200                             | A                  |
| 栅极发射极电压<br>Gate-Emitter Voltage  | $V_{GE}$                       | $\pm 20$                        | V                  |
| 耗散功率<br>Power Dissipation  | $P_D$ $T_C=25^{\circ}\text{C}$ | 600                             | W                  |
| 存储温度<br>Storage Temperature Range  | $T_{STG}$                      | $-55\sim+150$                   | $^{\circ}\text{C}$ |
| 结温<br>Junction Temperature Range   | $T_{vj}$                       | $-55\sim+175$                   | $^{\circ}\text{C}$ |
| 引线最高焊接温度<br>Maximum Lead Temperature for Soldering<br>Purposes                               | $T_L$                          | 300                             | $^{\circ}\text{C}$ |

\*注 1：连续集电极电流由最高结温限制

\*Note1: Collector current limited by maximum junction temperature



## 电特性 ELECTRICAL CHARACTERISTICS

| 项 目<br>Parameter                                  | 符 号<br>Symbol | 测试条件<br>Tests conditions                               | 最小<br>Min | 典型<br>Typ | 最大<br>Max | 单位<br>Units |
|---|---------------|--|-----------|-----------|-----------|-------------|
| <b>关态特性 Off –Characteristics</b>                  |               |  |           |           |           |             |
| 集电极-发射极击穿电压<br>Collector-Emitter Voltage          | $BV_{CES}$    | $I_C=250\mu A, V_{GE}=0V$                              | 1200      | -         | -         | V           |
| 零栅压下集电极漏电流<br>Zero Gate Voltage Collector Current | $I_{CES}$     | $V_{CE}=1200V, V_{GE}=0V, T_C=25^\circ C$              | -         | -         | 0.5       | mA          |
|   |               | $V_{CE}=1200V, V_{GE}=0V, T_C=175^\circ C$             | -         | 3         | -         | mA          |
| 正向栅极体漏电流<br>Gate-body leakage current,<br>forward | $I_{GESF}$    | $V_{CE}=0V, V_{GE}=20V$                                | -         | -         | 200       | nA          |
| 反向栅极体漏电流<br>Gate-body leakage current,<br>reverse | $I_{GESR}$    | $V_{CE}=0V, V_{GE}=-20V$                               | -         | -         | -200      | nA          |
| <b>通态特性 On-Characteristics</b>                    |               |  |           |           |           |             |
| 阈值电压<br>Gate Threshold Voltage                    | $V_{GE(th)}$  | $V_{CE} = V_{GE}, I_C=250\mu A$                        | 4.5       | -         | 6.5       | V           |
| 饱和压降<br>Collector-Emitter saturation Voltage      | $V_{CESAT}$   | $V_{GE}=15V, I_C=50A$<br>$T_C=25^\circ C$              | -         | 2.0       | 2.5       | V           |
|   |               | $V_{GE}=15V, I_C=50A$<br>$T_C=175^\circ C$             | -         | 2.5       | -         | V           |
| <b>动态特性 Dynamic Characteristics</b>               |               |  |           |           |           |             |
| 输入电容<br>Input capacitance                         | $C_{ies}$     | $V_{CE}=25V,$<br>$V_{GE}=0V,$<br>$f=1.0MHz$            | -         | 5.3       | -         | nF          |
| 输出电容<br>Output capacitance                        | $C_{oes}$     |  | -         | 0.29      | -         | nF          |
| 反向传输电容<br>Reverse transfer capacitance            | $C_{res}$     |  | -         | 0.05      | -         | nF          |
| 栅极电荷总量 Total Gate Charge                          | $Q_g$         | $V_{CC}=600V, I_C=50A, V_{GE}=15V$<br>$T_C=25^\circ C$ | -         | 168       | -         | nC          |
| 栅极电阻-Gate resistance                              | $R_g$         | $f=1MHz, \text{open collector}$                        | -         | 7         | -         | $\Omega$    |
| 短路电流-short current                                | $I_{SC}$      | $V_{GE}=15V, V_{CE}=600V, t_{sc} < 10\mu s$            | -         | 235       | -         | A           |





## 电特性 ELECTRICAL CHARACTERISTICS

| 开关特性 Switching Characteristics   |                   |  |           |           |           |               |
|--|-------------------|--|-----------|-----------|-----------|---------------|
| 项 目<br>Parameter   | 符 号<br>Symbol     | 测试条件<br>Tests conditions   | 最小<br>Min | 典型<br>Typ | 最大<br>Max | 单位<br>Units   |
| 开启延迟时间 Turn-on delay time  | $t_d(\text{on})$  | $V_{CC}=600V, I_c=50A, R_G=10\Omega$<br>$V_{GE}=15V$ , 感性负载<br>$T_C=25^\circ\text{C}$  | -         | 70        | -         | ns            |
| 上升时间 Turn-on rise time   | $t_r$             |  | -         | 114       | -         | ns            |
| 关断延迟时间 Turn-off delay time   | $t_d(\text{off})$ |  | -         | 224       | -         | ns            |
| 下降时间 Turn-off Fall time  | $t_f$             |  | -         | 166       | -         | ns            |
| 开通损耗 Turn-on energy  | $E_{on}$          |  | -         | 2.74      | -         | mJ            |
| 关断损耗 Turn-off energy   | $E_{off}$         |  | -         | 2.74      | -         | mJ            |
| 总开关损耗 Total switching energy   | $E_{tot}$         |  | -         | 5.48      | -         | mJ            |
| 开启延迟时间 Turn-on delay time  | $t_d(\text{on})$  | $V_{CC}=600V, I_c=50A, R_G=10\Omega$<br>$V_{GE}=15V$ , 感性负载<br>$T_C=175^\circ\text{C}$ | -         | 64        | -         | ns            |
| 上升时间 Turn-on rise time   | $t_r$             |  | -         | 118       | -         | ns            |
| 关断延迟时间 Turn-off delay time   | $t_d(\text{off})$ |  | -         | 256       | -         | ns            |
| 下降时间 Turn-off Fall time  | $t_f$             |  | -         | 328       | -         | ns            |
| 开通损耗 Turn-on energy  | $E_{on}$          |  | -         | 3.18      | -         | mJ            |
| 关断损耗 Turn-off energy   | $E_{off}$         |  | -         | 3.76      | -         | mJ            |
| 总开关损耗 Total switching energy   | $E_{tot}$         |  | -         | 6.94      | -         | mJ            |
| 反并联二极管特性及最大额定值 Anti-Parallel Diode Characteristics and Maximum Ratings |                   |  |           |           |           |               |
| 正向压降<br>Diode Forward Voltage  | $V_F$             | $V_{GE}=0V, I_F=50A, T_C=25^\circ\text{C}$   | -         | 1.85      | 2.5       | V             |
|  |                   | $V_{GE}=0V, I_F=50A, T_C=175^\circ\text{C}$  | -         | 1.45      | -         | V             |
| 反向恢复时间<br>Diode Reverse recovery time                                  | $t_{rr}$          | $V_{GE}=0V, V_R=600V, I_F=50A$<br>$di/dt=200A/\mu s$<br>$T_C=25^\circ\text{C}$         | -         | 486       | -         | ns            |
| 反向恢复电荷<br>Diode Reverse recovery charge                                | $Q_{rr}$          |  | -         | 3         | -         | $\mu\text{C}$ |
| 反向恢复电流<br>Diode Reverse recovery Current                               | $I_{RRM}$         |  | -         | 11        | -         | A             |

| 项 目<br>Parameter                                      | 符 号<br>Symbol | 最大值 MAX       |  | 单 位<br>Unit        |
|---|---------------|---------------|--|--------------------|
|   |               | JT050N120GPED |  |                    |
| 结到管壳的热阻 IGBT<br>Thermal Resistance, Junction to Case  | $R_{th(j-c)}$ | 0.25          |  | $^\circ\text{C/W}$ |
| 结到管壳的热阻 DIODE<br>Thermal Resistance, Junction to Case | $R_{th(j-c)}$ | 1.0           |  | $^\circ\text{C/W}$ |
| 结到环境的热阻<br>Thermal Resistance, Junction to Ambient    | $R_{th(j-A)}$ | 40.0          |  | $^\circ\text{C/W}$ |





特征曲线 ELECTRICAL CHARACTERISTICS (curves)

Output Characteristics (25°C)

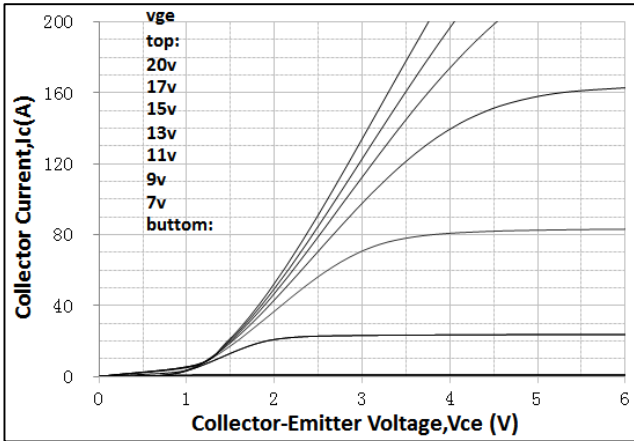

Output Characteristics (175°C)

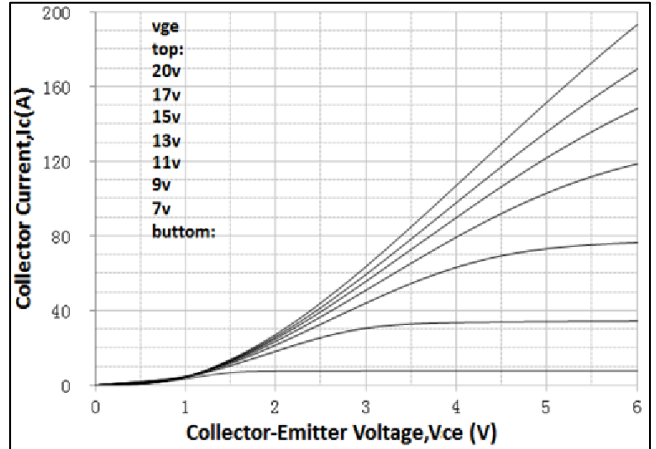

Transfer Characteristics

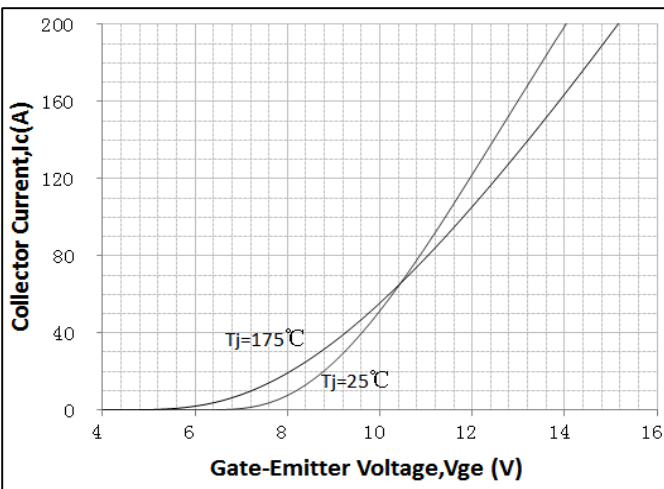

Vcesat vs. Tj

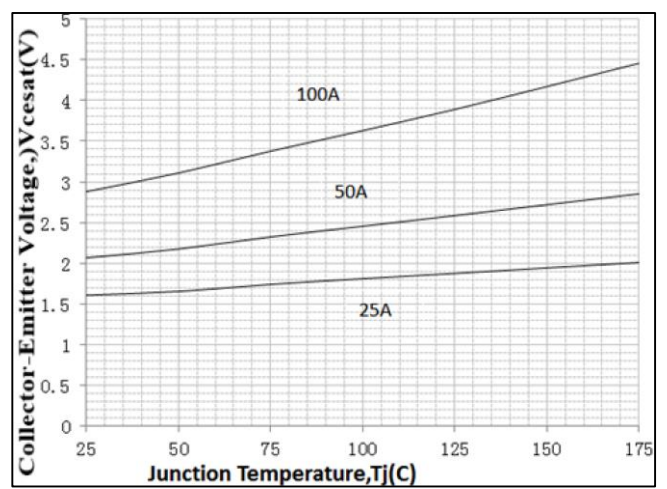

Diode Characteristic

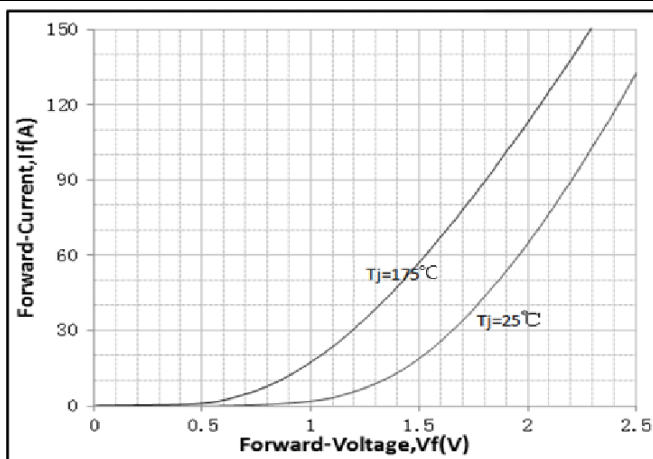

Gate Charge Characteristics

$V_{ce}=600\text{V}$ ,  $I_c=50\text{A}$

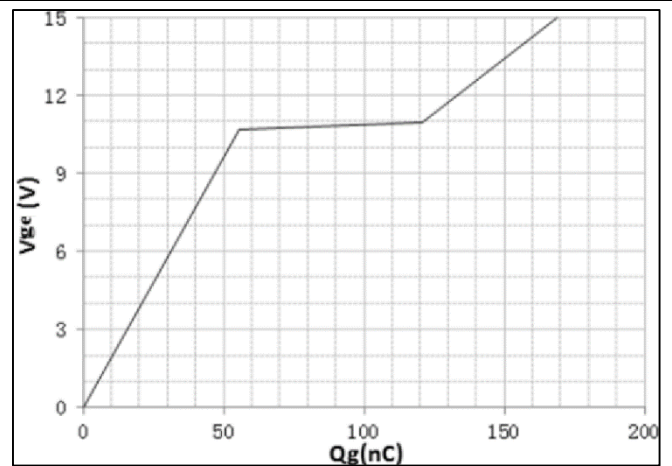



特征曲线 ELECTRICAL CHARACTERISTICS (curves)

Capacitance Characteristic

Vce=25V, VGE =0V, f=1.0MHZ

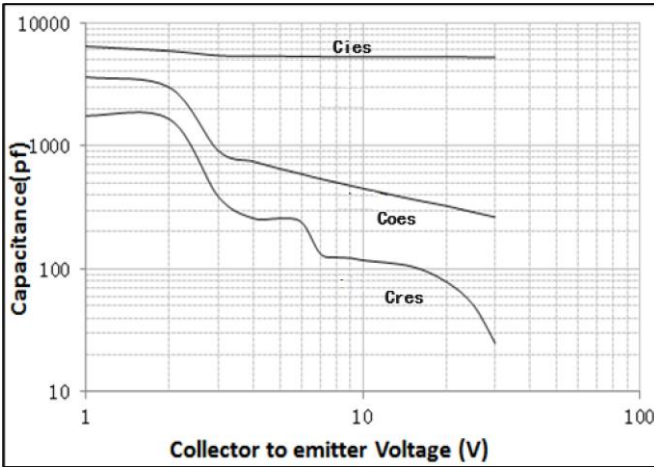

Collector current vs.case temperature

VGE≥15V, Tvj≤175°C

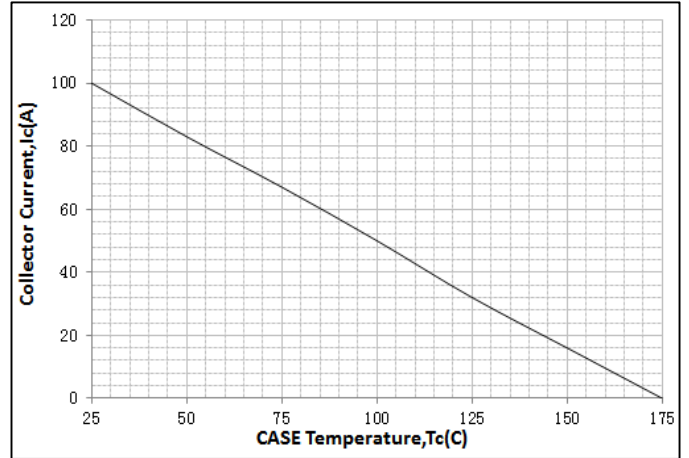

Switching Time vs. IC(25°C)

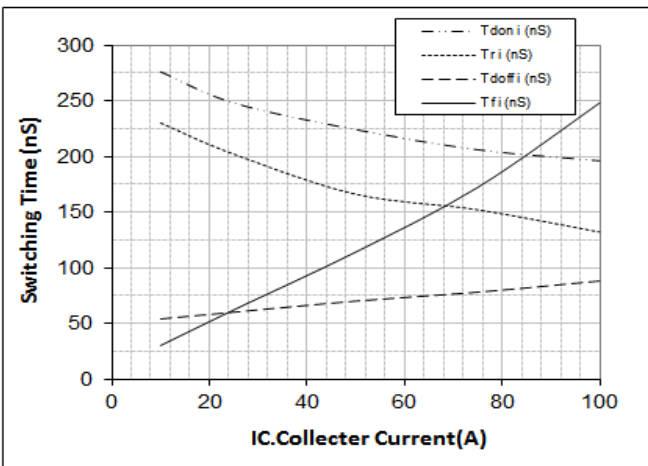

Switching Time vs. IC(175°C)

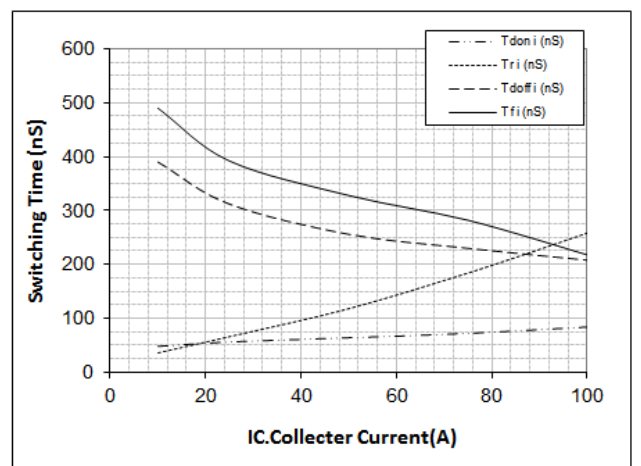

Switching Time vs. Rg(25°C)

VGE=15V, VCE=600V, IC=50A

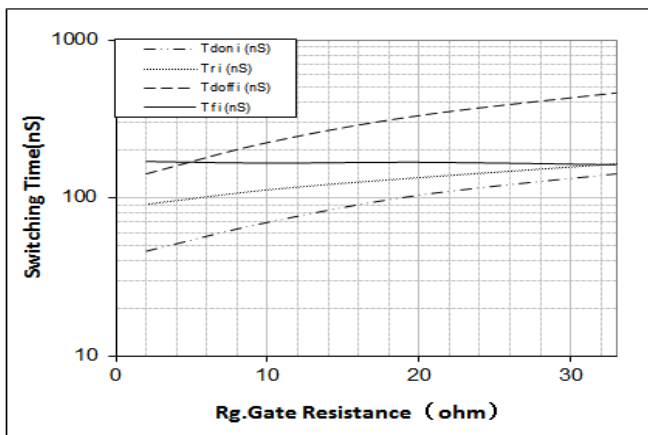

Switching Time vs. Rg(175°C)

VGE=15V, VCE=600V, IC=50A

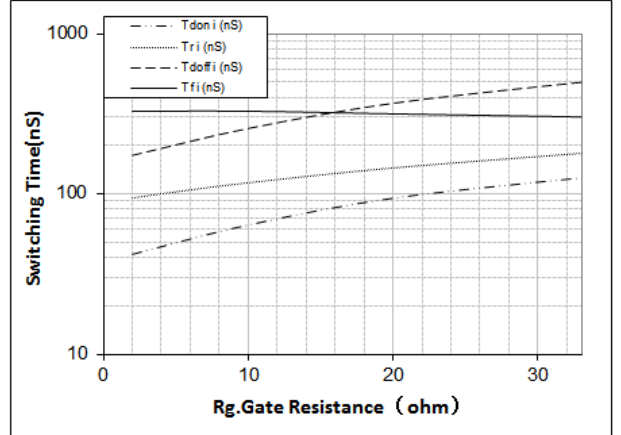





特征曲线 ELECTRICAL CHARACTERISTICS (curves)

Switching Time vs.Tj

VGE=15V, VCE=600V, IC=50A, Rg=10Ω

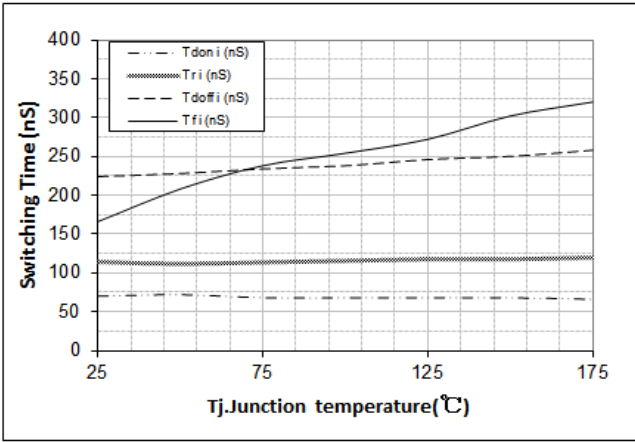

Switching Loss vs. Tj

VGE=15V, VCE=600V, IC=50A, Rg=10Ω

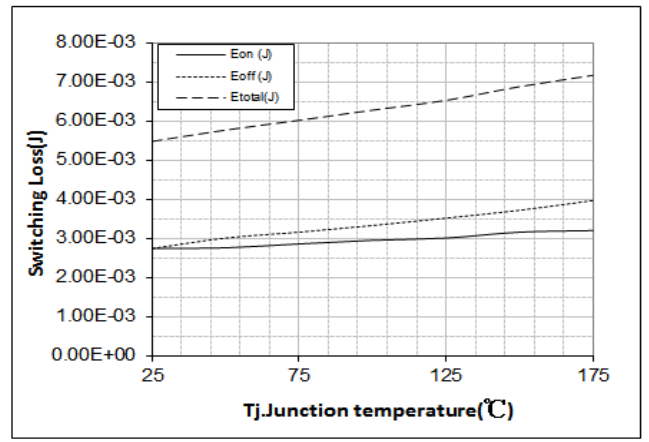

Switching Loss vs. IC(25°C)

VGE=15V, VCE=600V, Rg=10Ω

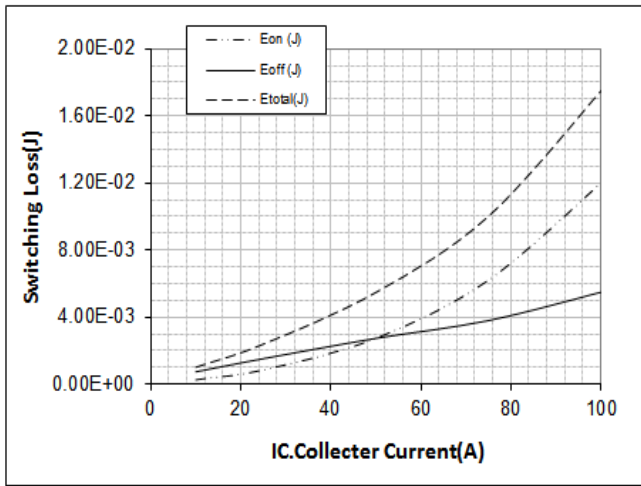

Switching Loss vs. IC(175°C)

VGE=15V, VCE=600V, Rg=10Ω

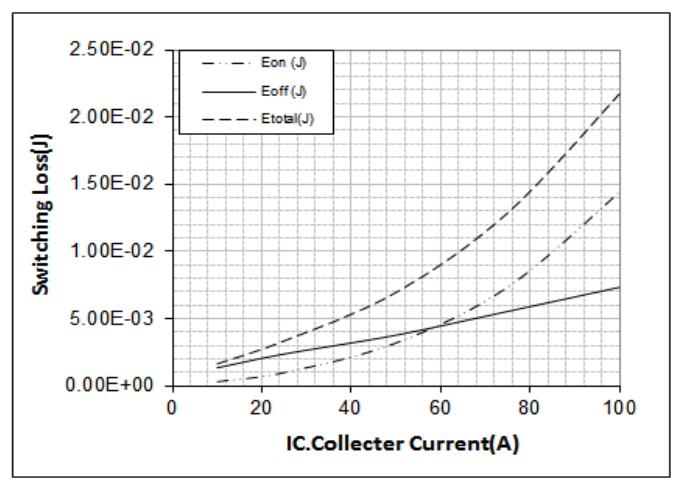

Switching Loss vs. Rg(25°C)

VGE=15V, VCE=600V, IC=50A

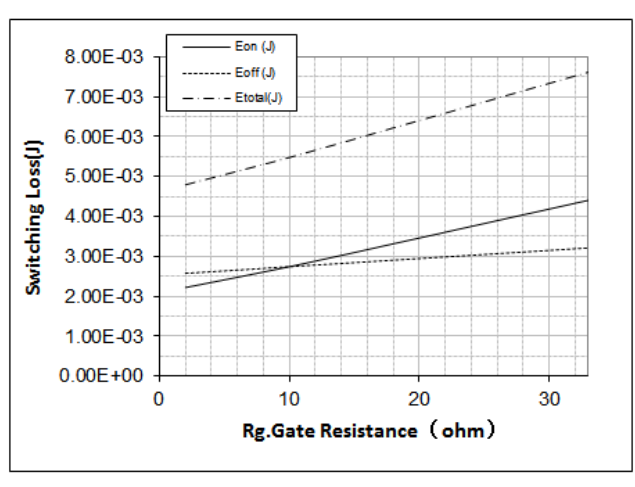

Switching Loss vs. Rg(175°C)

VGE=15V, VCE=600V, IC=50A

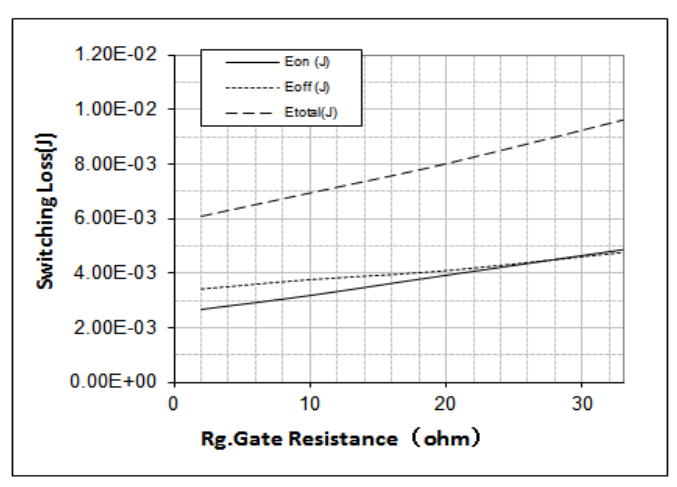



特征曲线 ELECTRICAL CHARACTERISTICS (curves)

Switching Loss vs.  $V_{CE}(175^{\circ}C)$

$V_{GE}=15V, I_C=50A, R_g=10\Omega$

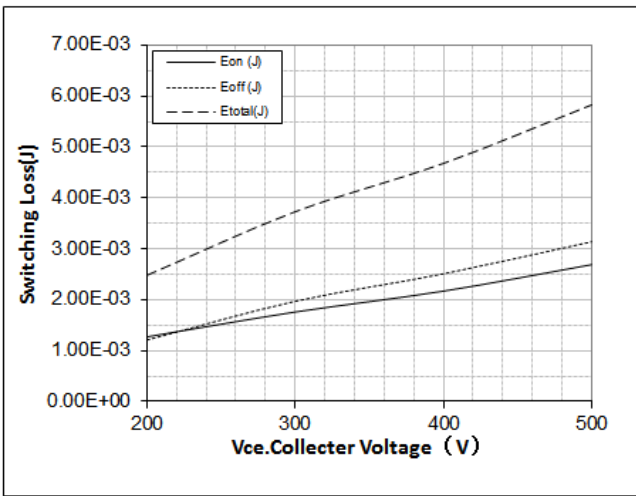

Forward Bias SOA

$T_c=25^{\circ}C, V_{GE}=15V, T_j \leq 175^{\circ}C$

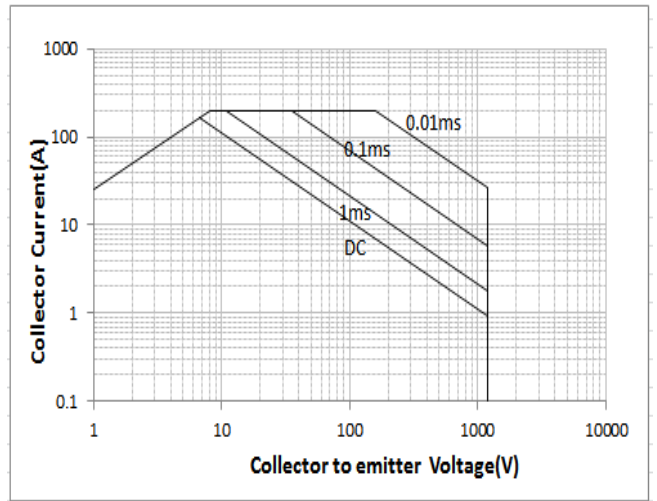

Normalized Maximum Transient Thermal Impedance for IGBT

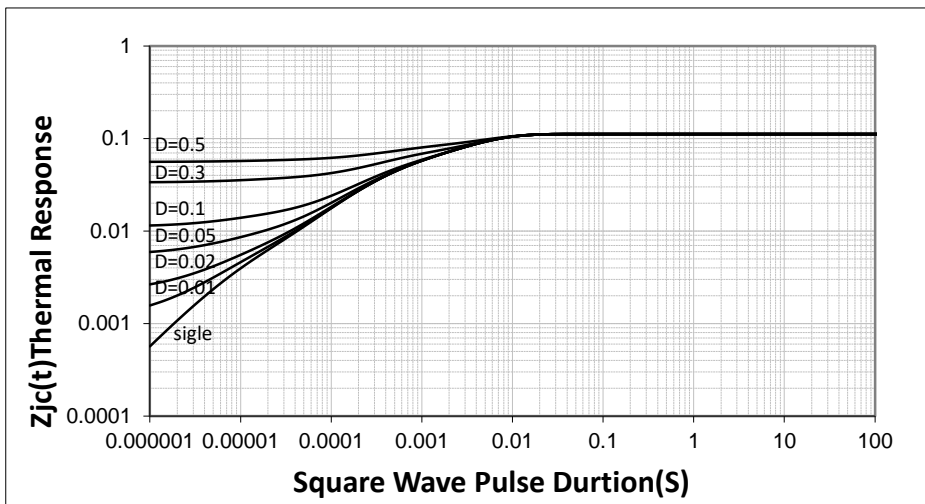

Normalized Maximum Transient Thermal Impedance for FRD

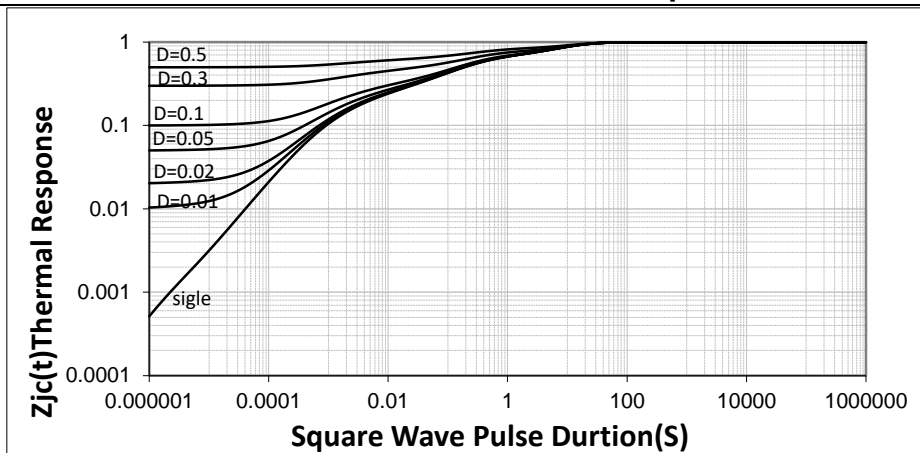





外形尺寸 PACKAGE MECHANICAL DATA

TO-247PLUS

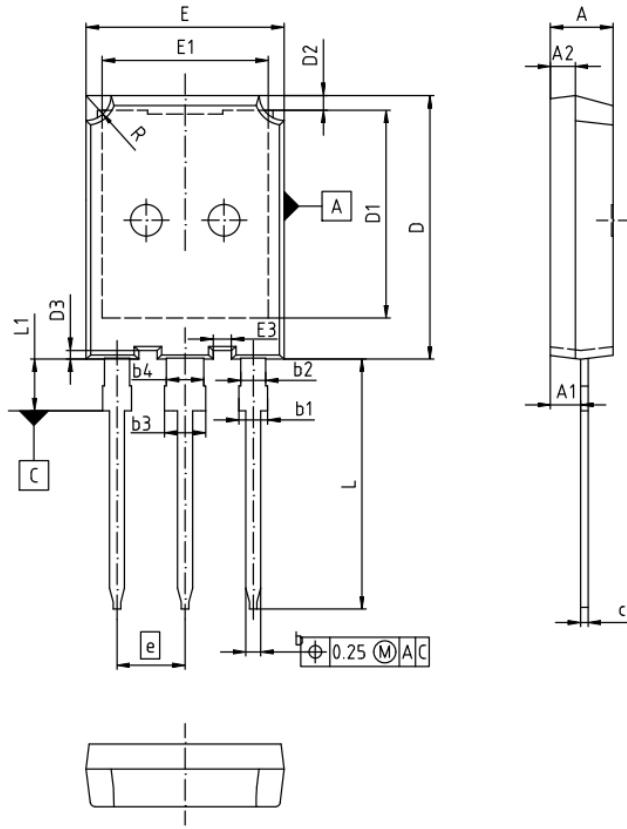

单位 Unit : mm

| DIM | MILLIMETERS |       | INCHES      |       |
|-----|-------------|-------|-------------|-------|
|     | MIN         | MAX   | MIN         | MAX   |
| A   | 4.90        | 5.10  | 0.193       | 0.201 |
| A1  | 2.31        | 2.51  | 0.091       | 0.099 |
| A2  | 1.90        | 2.10  | 0.075       | 0.083 |
| b   | 1.16        | 1.26  | 0.046       | 0.050 |
| b1  | 1.96        | 2.25  | 0.077       | 0.089 |
| b2  | 1.96        | 2.06  | 0.077       | 0.081 |
|     |             |       |             |       |
| c   | 0.59        | 0.66  | 0.023       | 0.026 |
| D   | 20.90       | 21.10 | 0.823       | 0.831 |
| D1  | 16.25       | 16.85 | 0.640       | 0.663 |
| D2  | 1.05        | 1.35  | 0.041       | 0.053 |
| D3  | 0.58        | 0.78  | 0.023       | 0.031 |
| E   | 15.70       | 15.90 | 0.618       | 0.626 |
| E1  | 13.10       | 13.50 | 0.516       | 0.531 |
| E3  | 1.35        | 1.55  | 0.053       | 0.061 |
| e   | 5.44 (BSC)  |       | 0.214 (BSC) |       |
| N   | 3           |       | 3           |       |
| L   | 19.80       | 20.10 | 0.780       | 0.791 |
| L1  | -           | 4.30  | -           | 0.169 |
| R   | 1.90        | 2.10  | 0.075       | 0.083 |



### 注意事项

1. 吉林华微电子股份有限公司的产品销售分为直销和销售代理，无论哪种方式，订货时请与公司核实。
2. 购买时请认清公司商标，如有疑问请与公司本部联系。
3. 在电路设计时请不要超过器件的绝对最大额定值，否则会影响整机的可靠性。
4. 本说明书如有版本变更不另外告知。

### NOTE

1. Jilin Sino-microelectronics co., Ltd sales its product either through direct sales or sales agent , thus, for customers, when ordering , please check with our company.
2. We strongly recommend customers check carefully on the trademark when buying our product, if there is any question, please don't be hesitate to contact us.
3. Please do not exceed the absolute maximum ratings of the device when circuit designing.
4. Jilin Sino-microelectronics co., Ltd reserves the right to make changes in this. specification sheet and is subject to change without prior notice.

### 联系方式

#### 吉林华微电子股份有限公司

公司地址：吉林省吉林市深圳街 99 号

邮编：132013

总机：86-432-64678411

传真：86-432-64665812

网址：[www.hwdz.com.cn](http://www.hwdz.com.cn)

### CONTACT

#### JILIN SINO-MICROELECTRONICS CO., LTD.

ADD: No.99 Shenzhen Street, Jilin City, Jilin Province, China.

Post Code: 132013

Tel: 86-432-64678411

Fax: 86-432-64665812

Web Site: [www.hwdz.com.cn](http://www.hwdz.com.cn)