



SJH20300

主要参数 MAIN CHARACTERISTICS

$I_{F(AV)}$	20 (2×10) A
V_{RRM}	300 V
T_j	150 °C
$V_{F(max)}$	0.85V (@ $T_j=125^{\circ}C$)

用途

- 高频开关电源
- 低压续流电路和保护电路

APPLICATIONS

- High frequency switch power supply
- Free wheeling diodes, polarity protection applications

产品特性

- 共阴结构
- 低功耗，高效率
- 高浪涌电流能力
- 高 ESD 能力
- 良好的高温特性
- 高可靠性
- 环保 (RoHS) 产品

FEATURES

- Common cathode structure
- Low power loss, high efficiency
- High surge current capability
- High ESD capability
- High Operating Junction Temperature
- High reliability
- RoHS product

封装 Package

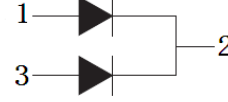

TO-220

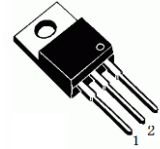

TO-220MF-K1

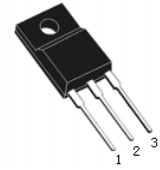

订货信息 ORDER MESSAGE

订货型号 Order codes				印记 Marking	封装 Package
有卤-条管 Halogen-Tube	无卤-条管 Halogen Free-Tube	有卤-编带 Halogen-Reel	无卤-编带 Halogen Free-Reel		
N/A	SJH20300-CA-BR	N/A	N/A	SJH20300	TO-220
N/A	SJH20300-F1-BR	N/A	N/A	SJH20300	TO-220MF-K1

绝对最大额定值 ABSOLUTE RATINGS ($T_c=25^\circ\text{C}$)

项 目 Parameter		符 号 Symbol	数 值 Value	单 位 Unit
最大反向重复峰值电压 Repetitive peak reverse voltage		V_{RRM}	300	V
最大直流阻断电压 Maximum DC blocking voltage		V_{DC}	300	V
正向平均整流电流 Average forward current	$T_c=122^\circ\text{C}$ (TO-220)	整个器件 per device	20	A
	$T_c=100^\circ\text{C}$ (TO-220MF-1)			
正向峰值浪涌电流 Surge non repetitive forward current (额定负载 8.3ms 半正弦波—按 JEDEC 方法) 8.3 ms single half-sine-wave (JEDEC Method)		I_{FSM}	180	A
最高结温 Maximum junction temperature		T_j	150	$^\circ\text{C}$
储存温度 Storage temperature range		T_{STG}	-40~+150	$^\circ\text{C}$

电特性 ELECTRICAL CHARACTERISTICS

项 目 Parameter	测试条件 Tests conditions		最小值 Value(min)	典型值 Value(typ)	最大值 Value(max)	单 位 Unit
I_R	$T_j=25^\circ\text{C}$	$V_R=V_{RRM}$			50	μA
	$T_j=125^\circ\text{C}$				10	mA
V_F	$T_j=25^\circ\text{C}$	$I_F=10\text{A}$		0.86	0.98	V
	$T_j=125^\circ\text{C}$			0.735	0.85	V

热特性 THERMAL CHARACTERISTICS

项 目 Parameter	符 号 Symbol	最小值 Value(min)	最大值 Value(max)	单 位 Unit
结到管壳的热阻 Thermal resistance from junction to case	$R_{th(j-c)}$		1.9 3.5	$^\circ\text{C}/\text{W}$



特征曲线 ELECTRICAL CHARACTERISTICS (curves)

IF vs VF

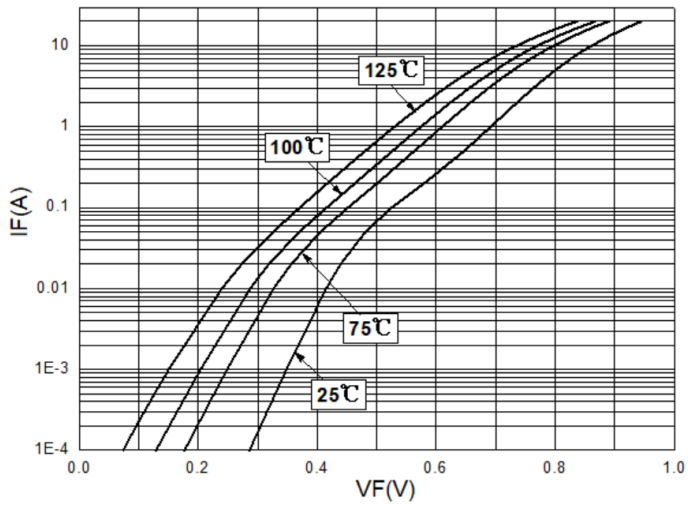

IR vs VR

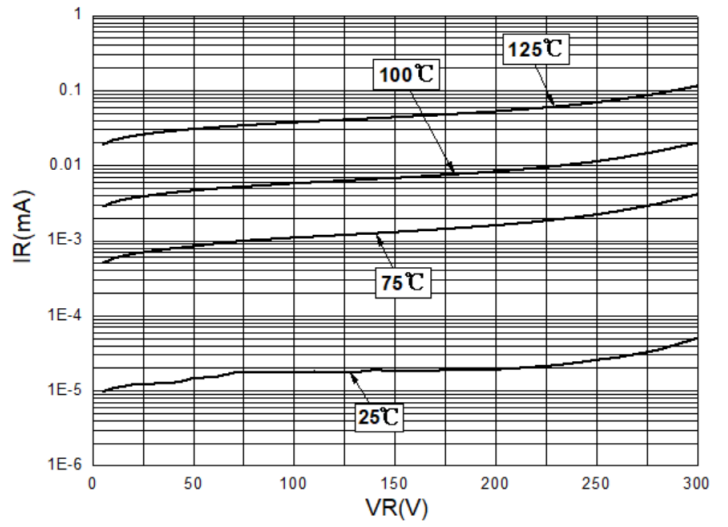

IF(AV) vs Tc

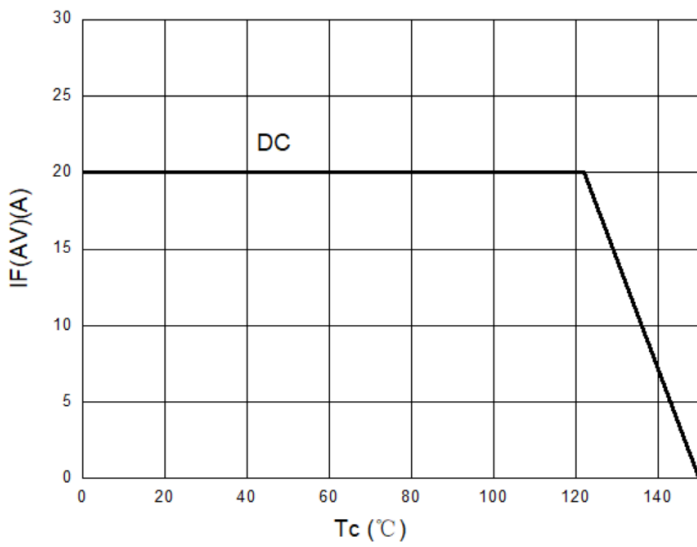

CT vs VR

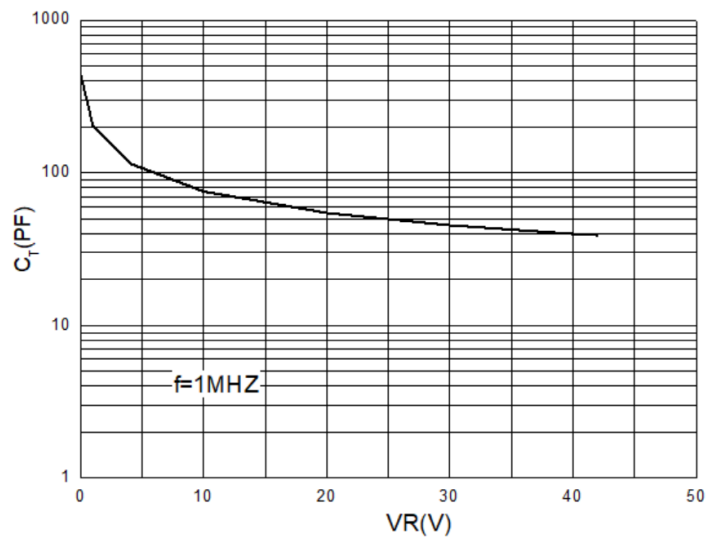

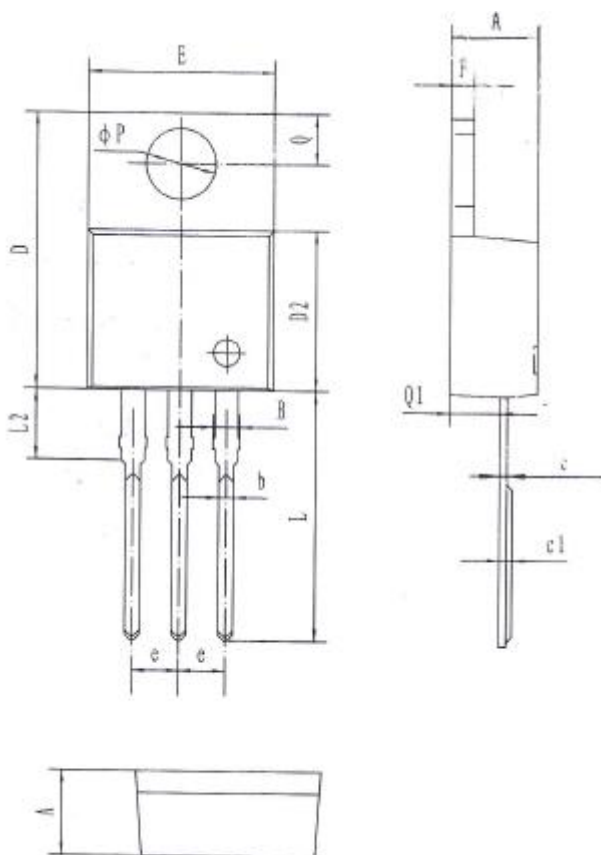

符号 symbol	MIN	MAX
A	4.40	4.80
B	1.10	1.40
b	0.70	0.95
c	0.28	0.48
c1	0.32	0.52
D	14.45	16.00
D2	8.20	9.20
E	9.60	10.40
e	2.39	2.69
F	1.20	1.35
L	13.05	14.05
L2	3.70	3.90
Q	2.40	3.00
Q1	2.20	2.90
P	3.50	4.00



外形尺寸 PACKAGE MECHANICAL DATA
TO-220MF-K1

单位 Unit : mm

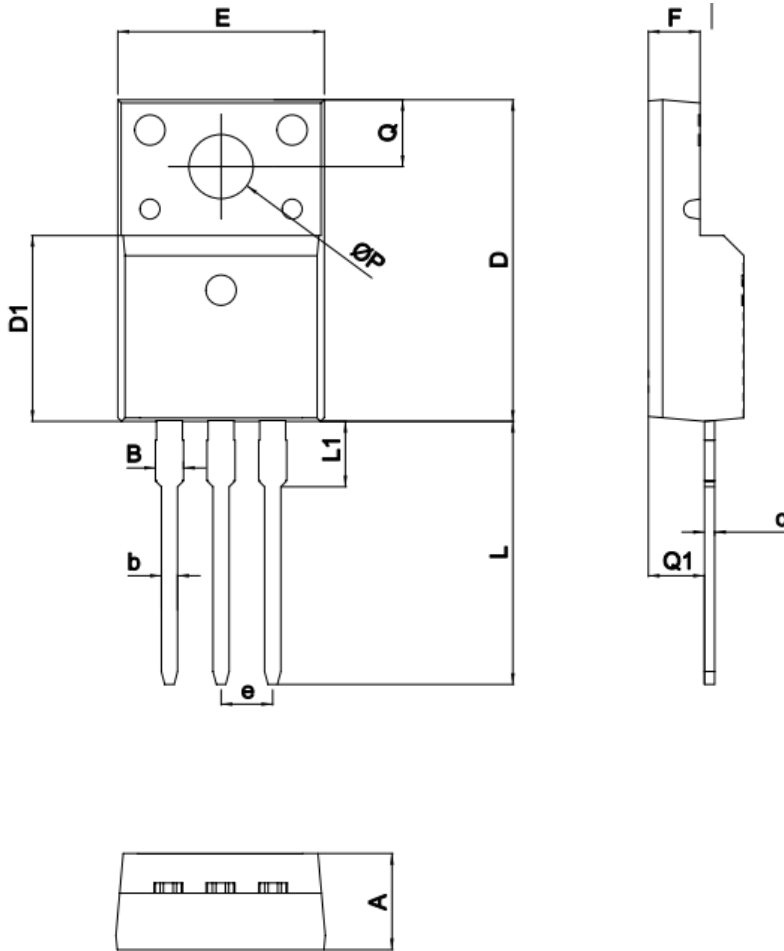

SYMBOL	mm	
	MIN	MAX
A	4.5	4.9
B	1.22	1.47
b	0.7	0.9
c	0.45	0.60
D	15.6	16.1
D1	9.0	9.3
e	2.54TYPE	
E	9.9	10.4
F	2.3	2.8
L	12.6	13.3
L1	3.1	3.4
Q	3.2	3.4
Q1	2.6	2.9
ØP	3.0	3.5



注意事项

1. 吉林华微电子股份有限公司的产品销售分为直销和销售代理，无论哪种方式，订货时请与公司核实。
2. 购买时请认清公司商标，如有疑问请与公司本部联系。
3. 在电路设计时请不要超过器件的绝对最大额定值，否则会影响整机的可靠性。
4. 本说明书如有版本变更不另外告知。

NOTE

1. Jilin Sino-microelectronics co., Ltd sales its product either through direct sales or sales agent , thus, for customers, when ordering , please check with our company.
2. We strongly recommend customers check carefully on the trademark when buying our product, if there is any question, please don't be hesitate to contact us.
3. Please do not exceed the absolute maximum ratings of the device when circuit designing.
4. Jilin Sino-microelectronics co., Ltd reserves the right to make changes in this. specification sheet and is subject to change without prior notice.

联系方式

吉林华微电子股份有限公司

公司地址：吉林省吉林市深圳街 99 号

邮编：132013

总机：86-432-64678411

传真：86-432-64665812

网址：www.hwdz.com.cn

CONTACT

JILIN SINO-MICROELECTRONICS CO., LTD.

ADD: No.99 Shenzhen Street, Jilin City, Jilin Province, China.

Post Code: 132013

Tel: 86-432-64678411

Fax: 86-432-64665812

Web Site: www.hwdz.com.cn